

MPFX series

Maximum working pressure up to 800 kPa (8 bar) - Flow rate up to 750 l/min





THE NEW FILTER CONCEPT

MPFX
MPTX
MFBX
MFX
series

NEW FILTER ELEMENT WITH EXCLUSIVE INTERFACE CONNECTION

- Protects the machine from improper use of non-original products.
- Safety of constant quality protection & reliability

With exclusive filter element you are sure that only MP Filtri filter elements can be used, ensuring the best cleaning level of the oil due to the use of originals filter elements.



The products identified as MPFX, MPTX, MFBX and MFX are protected by Italian Patent n° 102015000040473 and by one or more of the following patent applications:

European Patent Pending: n° 16181725.9

US Patent Pending: n° 15/224,337

Canadian Patent Pending: n° 2,937,258

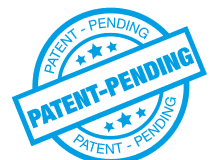

Description

Technical data

Return filter

Maximum working pressure up to 800 kPa (8 bar)
Flow rate up to 750 l/min

MPFX is a range of return filters for protection of the reservoir against the system contamination.

They are directly fixed to the reservoir, in immersed or semi-immersed position.

The filter output must be always immersed into the fluid to avoid aeration or foam generation into the reservoir.

Available features:

- Female threaded connections up to 2" and flanged connections up to 2", for a maximum flow rate of 750 l/min
- Multiple connections, to connect several return lines or drains
- Fine filtration rating, to get a good cleanliness level into the reservoir
- Bypass valve integrated into the filter element, to relieve excessive pressure drop across the filter media
- 2, 3 or 4 fixing holes for installation, to meet any reservoir surface flatness and roughness
- O-ring or Flat seal, to meet any reservoir surface flatness and roughness
- Oil dipstick, to easily check the level of the fluid into the reservoir (sold as separate item)
- Extension tube, to be used in deep reservoirs (sold as separate item)
- Diffuser, to reduce the risk of aeration, foaming and noise (sold as separate item)
- Filler plug, to fill cleaned fluid into the tank without an additional connection
- Visual, electrical and electronic clogging indicators
- MYclean interface connection, to protect the product against non-original spare parts
- External protective wrap, to optimize the flow through the element and to save the element efficiency against non-proper handling

Common applications:

- Light Industrial equipment
- Mobile application

Filter housing materials

- Head: Aluminium
- Cover
Nylon: MPFX 030-100-104-110
Aluminium: MPFX 181-182-184-191-192-194-400-410-450-451-750
- Bowl: Nylon

Bypass valve

- Opening pressure 175 kPa (1.75 bar) ±10%
- Opening pressure 300 kPa (3 bar) ±10%

Δp element type

- Microfiber filter elements - series H: 10 bar
- Fluid flow through the filter element from OUT to IN

Seals

- Standard NBR series A
- Optional FPM series V

Temperature

From -25 °C to +110 °C

Note

MPFX filters are provided for vertical mounting



Weights [kg] and volumes [dm³]

Filter series	Weights [kg]				Volumes [dm ³]					
	Length	1	2	3	4	Length	1	2	3	4
MPFX 030		0.40	-	-	-		0.29	-	-	-
MPFX 100		0.61	0.64	0.67	0.74		0.64	0.85	1.20	1.65
MPFX 104		0.82	0.96	1.02	1.25		0.64	0.85	1.20	1.65
MPFX 110		0.64	0.68	0.71	0.78		-	-	-	-
MPFX 181		2.20	3.00	-	-		2.50	4.00	-	-
MPFX 182		2.30	3.10	-	-		2.50	4.00	-	-
MPFX 184		2.55	3.45	-	-		2.65	4.45	-	-
MPFX 191		-	3.00	-	-		-	4.25	-	-
MPFX 192		-	3.10	-	-		-	4.25	-	-
MPFX 194		-	3.45	-	-		-	4.45	-	-
MPFX 400		3.35	3.65	3.90	-		3.70	4.60	5.40	-
MPFX 410		3.55	3.85	4.10	-		3.70	4.60	5.40	-
MPFX 450-451		3.95	4.25	4.50	-		3.70	4.60	5.40	-
MPFX 750		6.30	-	-	-		8.45	-	-	-

Filter housings Δp pressure drop

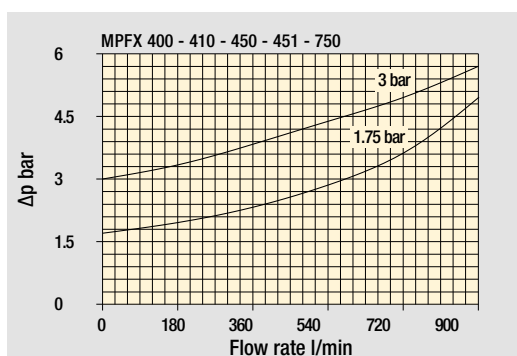
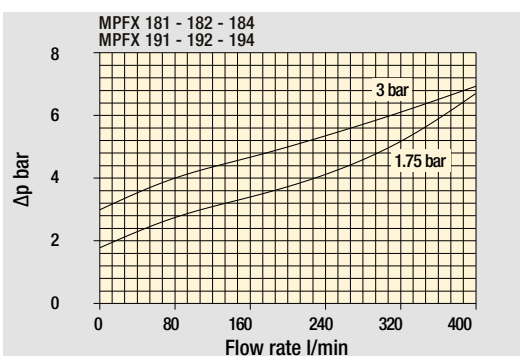
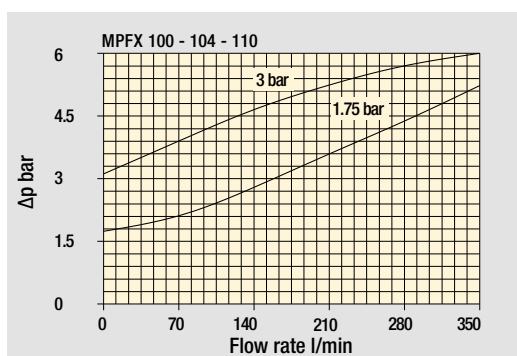
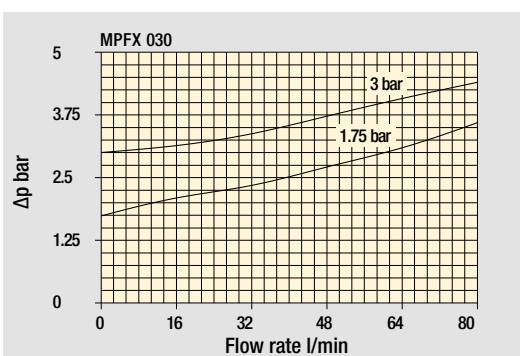
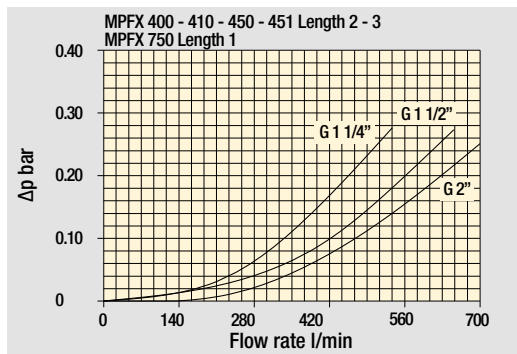
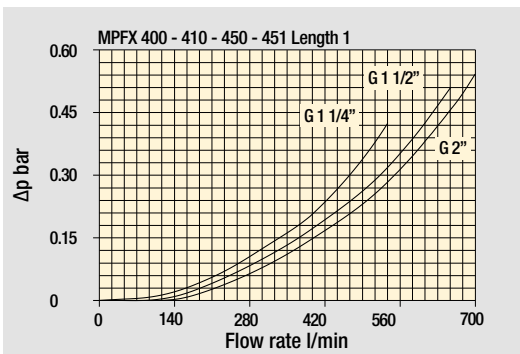
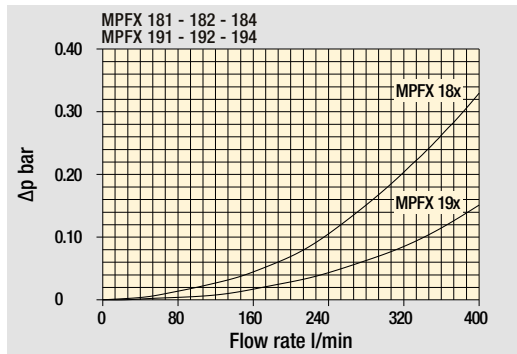
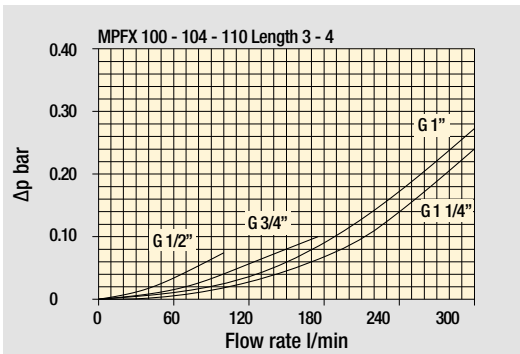
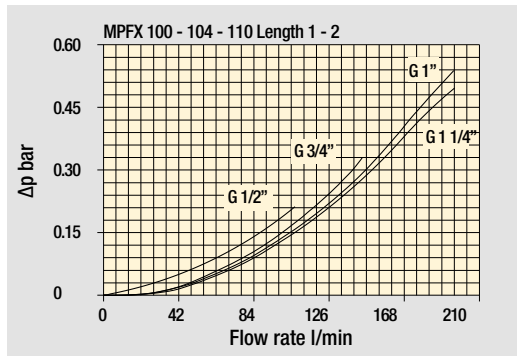
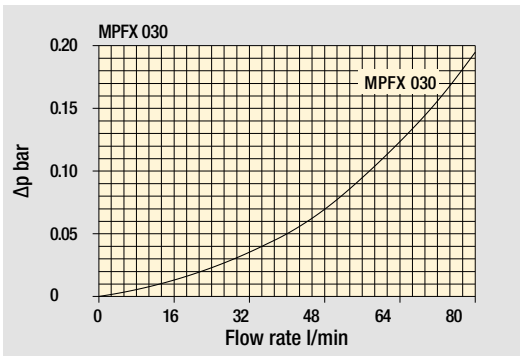

Bypass valve pressure drop

The curves are plotted using mineral oil with density of 0.86 kg/dm³ in compliance with ISO 3968.
 Δp varies proportionally with density.

MPFX GENERAL INFORMATION

Flow rates [l/min]

Filter series	Length	Filter element design - H series					Filter element design - N series		
		A03	A06	A10	A16	A25	M25 M60 M90	P10	P25
MPFX 030	1	7	10	24	29	47	84	60	66
MPFX 100-104-110	1	18	20	53	56	65	153	87	96
	2	28	38	65	75	95	158	111	123
	3	48	55	125	135	169	289	224	251
	4	79	89	180	185	198	306	264	289
MPFX 181-182-184	1	127	148	235	243	278	441	285	299
	2	231	262	358	382	388	472	404	412
MPFX 191-192-194	2	261	305	489	528	546	696	583	598
MPFX 400	1	150	171	294	304	350	585	370	390
	2	237	252	454	462	589	868	619	645
	3	248	288	553	609	621	885	680	703
MPFX 410	1	146	167	277	285	325	512	341	357
	2	226	239	396	402	485	644	503	519
	3	236	269	462	497	505	653	539	553
MPFX 450-451	1	150	171	294	304	350	585	370	390
	2	237	252	454	462	589	868	619	645
	3	248	288	553	609	621	885	680	703
MPFX 750	1	392	465	623	700	769	929	804	819

Maximum flow rate for a complete return filter with a pressure drop $\Delta p = 0.5$ bar.

The reference fluid has a kinematic viscosity of 30 mm²/s (cSt) and a density of 0.86 kg/dm³.

For different pressure drop or fluid viscosity we recommend to use our selection software available on www.mpfiltri.com.

Please, contact our Sales Department for further additional information.

Hydraulic symbols

Filter series	Style 1 connection	Style 2 connections
MPFX 030	•	
MPFX 100	•	
MPFX 104	•	
MPFX 110		•
MPFX 181	•	
MPFX 182		•
MPFX 184	•	•
MPFX 191	•	
MPFX 192	•	
MPFX 194	•	•
MPFX 400	•	
MPFX 410		•
MPFX 450	•	
MPFX 451		•
MPFX 750	•	

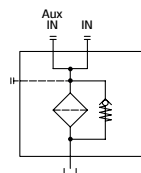
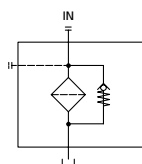

MPFX MPFX100 - MPFX104

Designation & Ordering code

COMPLETE FILTER

Series and size		Configuration example 1: MPFX100 2 W G3 A06 W B P01									
MPFX100 MPFX104 Filter element with private spigot		Configuration example 2: MPFX104 4 A G8 P10 N E P01									
Length											
1 2 3 4											
Seals and treatments											
A NBR											
V FPM											
W NBR head anodized											
Z FPM head anodized											
Connections		Size 100		Size 104		Connections		Size 100		Size 104	
G1 G 1/2"		•		•		G7 SAE 8 - 3/4" - 16 UNF		•		•	
G2 G 3/4"		•		•		G8 SAE 12 - 1 1/16" - 12 UN		•		•	
G3 G 1"		•		•		G9 SAE 16 - 1 5/16" - 12 UN		•		•	
G4 1/2" NPT		•		•		G10 G 1 1/4"		•			
G5 3/4" NPT		•		•		G11 1 1/4" NPT		•			
G6 1" NPT		•		•		G12 SAE 20 - 1 5/8" - 12 UN		•			
Filtration rating (filter media)											
A03 Inorganic microfiber 3 µm											
A06 Inorganic microfiber 6 µm											
A10 Inorganic microfiber 10 µm											
A16 Inorganic microfiber 16 µm											
A25 Inorganic microfiber 25 µm											
M25 Wire mesh 25 µm											
M60 Wire mesh 60 µm											
M90 Wire mesh 90 µm											
P10 Resin impregnated paper 10 µm											
P25 Resin impregnated paper 25 µm											
Element Δp				Filter media							
				Axx Mxx Pxx							
N 10 bar				•		•					
H 10 bar				•							
W 10 bar, compatible with fluids HFA, HFB and HFC				•		•					
								Bypass valve		Execution	
								E 3 bar		P01 MP Filtri standard	
								B 1.75 bar		Pxx Customized	

FILTER ELEMENT

Element series and size		Configuration example 1: MPFX100 2 A06 W B P01									
MPFX100 Filter element with private spigot		Configuration example 2: MPFX100 4 P10 N B E P01									
Element length											
1 2 3 4											
Filtration rating (filter media)											
A03 Inorganic microfiber 3 µm											
A06 Inorganic microfiber 6 µm											
A10 Inorganic microfiber 10 µm											
A16 Inorganic microfiber 16 µm											
A25 Inorganic microfiber 25 µm											
M25 Wire mesh 25 µm											
M60 Wire mesh 60 µm											
M90 Wire mesh 90 µm											
P10 Resin impregnated paper 10 µm											
P25 Resin impregnated paper 25 µm											
Element Δp				Filter media							
				Axx Mxx Pxx							
N 10 bar				•		•					
H 10 bar				•							
W 10 bar, compatible with fluids HFA, HFB and HFC				•		•					
								Seals		Bypass valve	
								B NBR		E 3 bar	
								V FPM		1.75 bar	
										Execution	
										P01 MP Filtri standard	
										Pxx Customized	

ACCESSORIES

Indicators		page		page	
BVA Axial pressure gauge	240	BEA Electrical pressure indicator	239		
BVR Radial pressure gauge	240	BEM Electrical pressure indicator	239		
BVP Visual pressure indicator with automatic reset	241	BLA Electrical / visual pressure indicator	239-240		
BVQ Visual pressure indicator with manual reset	241				
Additional features		page		page	
TE Extension tube	248	T5 Filler plug M30x1.5	249		
DFS Diffuser with fast lock connection	249	DPT Dipstick	249		

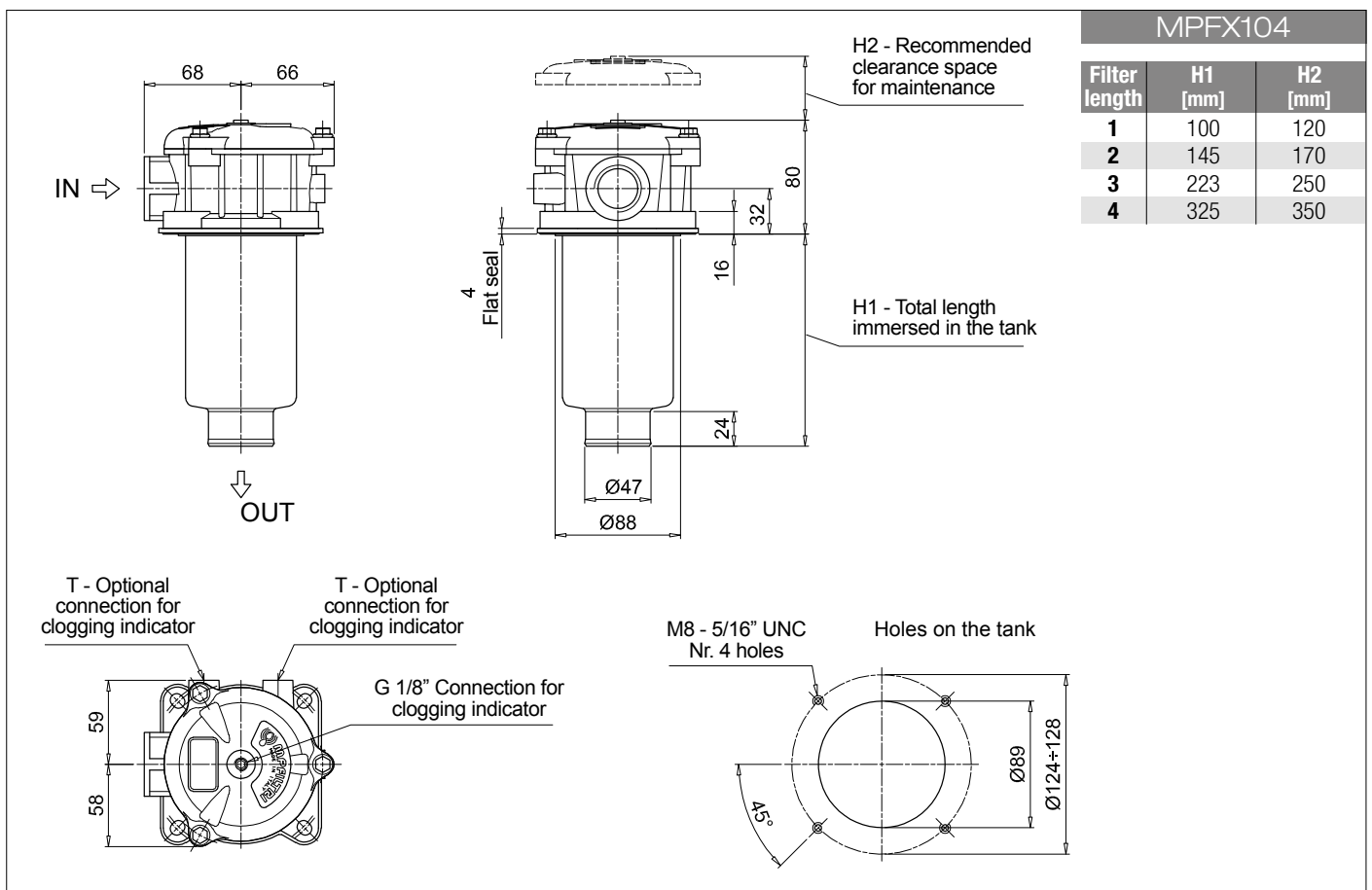
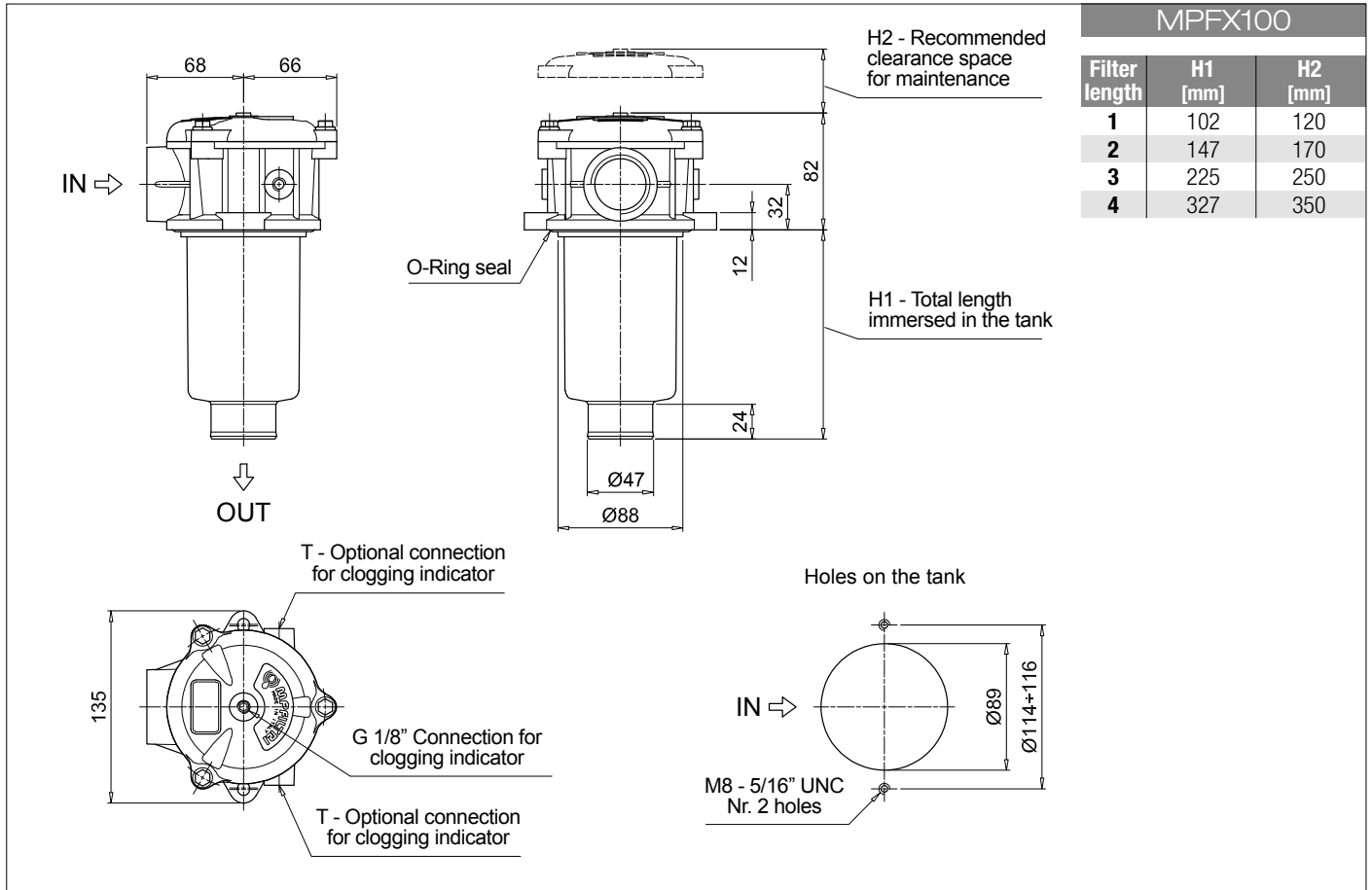

MPFX 100

MPFX 181

O-RING SEAL			
	Q.ty: 1 pc.	Q.ty: 1 pc.	
Item:	2	3 (3a ÷ 3d)	
Filter series	Filter element	Seal Kit code number	
		NBR	FPM
MPFX 030	See order table	02050675	02050676
MPFX 100-110		02050677	02050678
MPFX 181-182		02050681	02050682
MPFX 184		02050685	02050686
MPFX 191-192		02050683	02050684
MPFX 194		02050687	02050688
MPFX 400-410		02050695	02050696
MPFX 450-451		02050697	02050698
MPFX 750		02050699	02050700

MPFX 104

MPFX 181

FLAT SEAL			
	Q.ty: 1 pc.	Q.ty: 1 pc.	
Item:	2	3 (3a ÷ 3d)	
Filter series	Filter element	Seal Kit code number	
		NBR	FPM
MPFX 104	See order table	02050679	02050680
MPFX 181-182		02050691	02050692
MPFX 191-192		02050691	02050692