

# MPF series

Maximum working pressure up to 800 kPa (8 bar) - Flow rate up to 750 l/min



## Description

## Technical data

### Return filter

**Maximum working pressure up to 800 kPa (8 bar)**  
**Flow rate up to 750 l/min**

MPF is a range of return filters for protection of the reservoir against the system contamination.

They are directly fixed to the reservoir, in immersed or semi-immersed position.

The filter output must be always immersed into the fluid to avoid aeration or foam generation into the reservoir.

### Available features:

- Female threaded connections up to 2" and flanged connections up to 2", for a maximum flow rate of 750 l/min
- Multiple connections, to connect several return lines or drains
- Fine filtration rating, to get a good cleanliness level into the reservoir
- Bypass valve integrated into the filter element, to relieve excessive pressure drop across the filter media
- 2, 3 or 4 fixing holes for installation, to meet any reservoir surface flatness and roughness
- O-ring or Flat seal, to meet any reservoir surface flatness and roughness
- Oil dipstick, to easily check the level of the fluid into the reservoir (sold as separate item)
- Extension tube, to be used in deep reservoirs (sold as separate item)
- Diffuser, to reduce the risk of aeration, foaming and noise (sold as separate item)
- Filler plug, to fill cleaned fluid into the tank without an additional connection
- Visual, electrical and electronic clogging indicators

### Common applications:

- Light industrial equipment
- Mobile application

### Filter housing materials

- Head: Aluminium
- Cover  
Nylon: MPF 020-030-100-104-110  
Aluminium: MPF 181-182-184-191-192-194-400-410-450-451-750
- Bowl: Nylon

### Bypass valve

- Opening pressure 175 kPa (1.75 bar) ±10%
- Opening pressure 300 kPa (3 bar) ±10%

### Δp element type

- Microfibre filter elements - series H: 10 bar
- Fluid flow through the filter element from OUT to IN

### Seals

- Standard NBR series A
- Optional FPM series V

### Temperature

From -25 °C to +110 °C

### Note

MPF filters are provided for vertical mounting



## Weights [kg] and volumes [dm<sup>3</sup>]

Filter series	Weights [kg]				Volumes [dm <sup>3</sup> ]					
	Length	1	2	3	4	Length	1	2	3	4
<b>MPF 020</b>		0.30	-	-	-		0.26	-	-	-
<b>MPF 030</b>		0.40	-	-	-		0.29	-	-	-
<b>MPF 100</b>		0.61	0.64	0.67	0.74		0.64	0.85	1.20	1.65
<b>MPF 104</b>		0.82	0.96	1.02	1.25		0.64	0.85	1.20	1.65
<b>MPF 110</b>		0.64	0.68	0.71	0.78		-	-	-	-
<b>MPF 181</b>		2.20	3.00	-	-		2.50	4.00	-	-
<b>MPF 182</b>		2.30	3.10	-	-		2.50	4.00	-	-
<b>MPF 184</b>		2.55	3.45	-	-		2.65	4.45	-	-
<b>MPF 191</b>		-	3.00	-	-		-	4.25	-	-
<b>MPF 192</b>		-	3.10	-	-		-	4.25	-	-
<b>MPF 194</b>		-	3.45	-	-		-	4.45	-	-
<b>MPF 400</b>		3.35	3.65	3.90	-		3.70	4.60	5.40	-
<b>MPF 410</b>		3.55	3.85	4.10	-		3.70	4.60	5.40	-
<b>MPF 450-451</b>		3.95	4.25	4.50	-		3.70	4.60	5.40	-
<b>MPF 750</b>		6.30	-	-	-		8.45	-	-	-

### Filter housings $\Delta p$ pressure drop

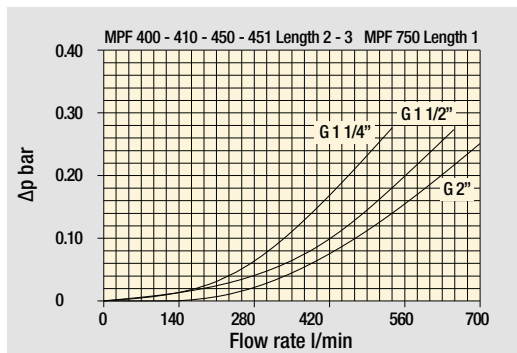
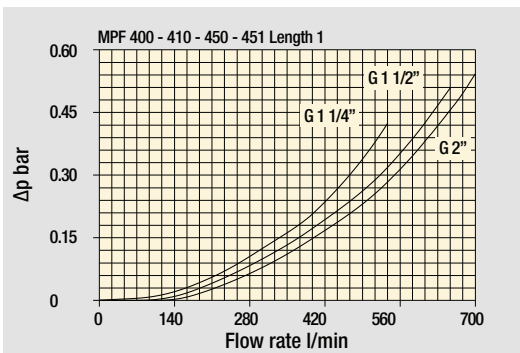
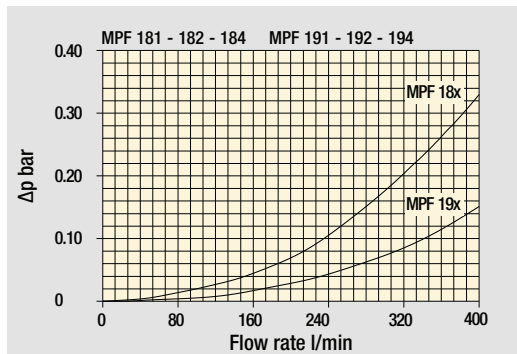
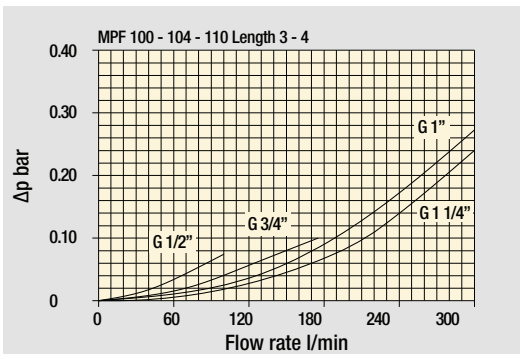
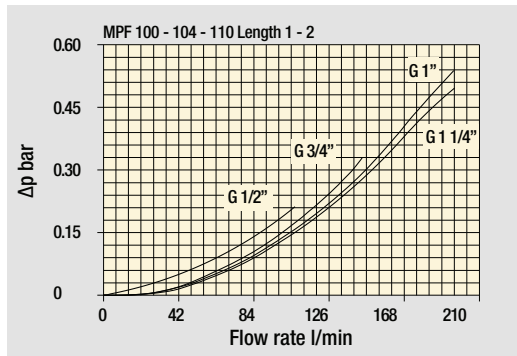
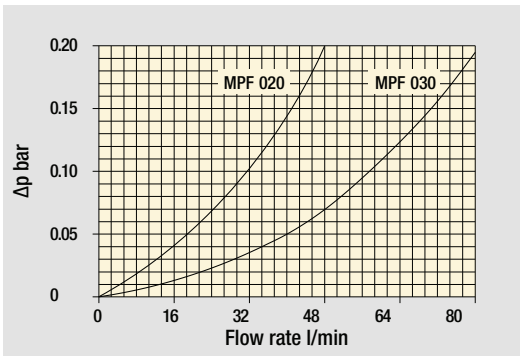

### Bypass valve pressure drop

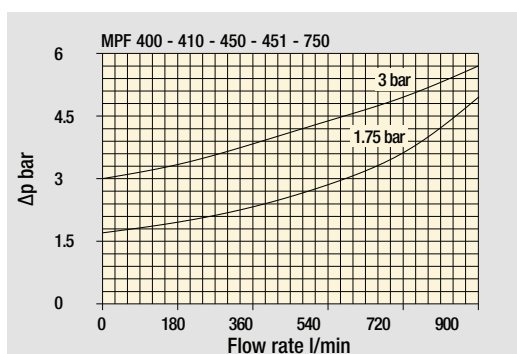
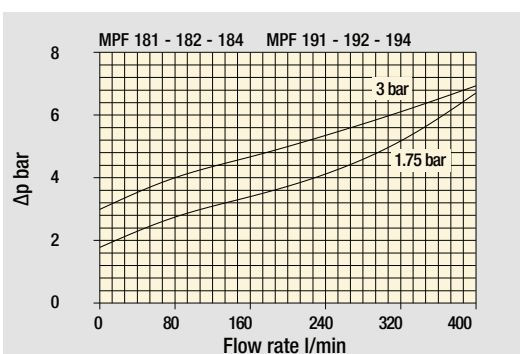
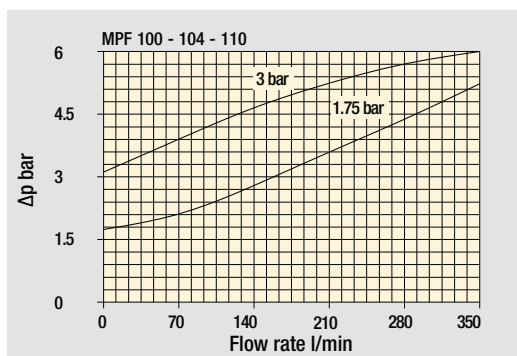
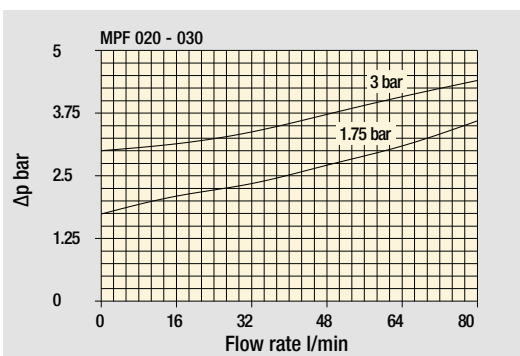

The curves are plotted using mineral oil with density of 0.86 kg/dm<sup>3</sup> in compliance with ISO 3968.  
 $\Delta p$  varies proportionally with density.

# MPF GENERAL INFORMATION

Flow rates [l/min]

Filter series	Length	Filter element design - H series					Filter element design - N series		
		A03	A06	A10	A16	A25	M25 M60 M90	P10	P25
<b>MPF 020</b>	<b>1</b>	7	10	23	28	42	59	51	54
<b>MPF 030</b>	<b>1</b>	7	10	24	29	47	84	60	66
<b>MPF 100-104-110</b>	<b>1</b>	18	20	53	56	65	153	87	96
	<b>2</b>	28	38	65	75	95	158	111	123
	<b>3</b>	48	55	125	135	169	289	224	251
	<b>4</b>	79	89	180	185	198	306	264	289
<b>MPF 181-182-184</b>	<b>1</b>	127	148	235	243	278	441	285	299
	<b>2</b>	231	262	358	382	388	472	404	412
<b>MPF 191-192-194</b>	<b>2</b>	261	305	489	528	546	696	583	598
<b>MPF 400</b>	<b>1</b>	150	171	294	304	350	585	370	390
	<b>2</b>	237	252	454	462	589	868	619	645
	<b>3</b>	248	288	553	609	621	885	680	703
<b>MPF 410</b>	<b>1</b>	146	167	277	285	325	512	341	357
	<b>2</b>	226	239	396	402	485	644	503	519
	<b>3</b>	236	269	462	497	505	653	539	553
<b>MPF 450-451</b>	<b>1</b>	150	171	294	304	350	585	370	390
	<b>2</b>	237	252	454	462	589	868	619	645
	<b>3</b>	248	288	553	609	621	885	680	703
<b>MPF 750</b>	<b>1</b>	392	465	623	700	769	929	804	819

## Maximum flow rate for a complete return filter with a pressure drop $\Delta p = 0.5$ bar.

The reference fluid has a kinematic viscosity of 30 mm<sup>2</sup>/s (cSt) and a density of 0.86 kg/dm<sup>3</sup>.

For different pressure drop or fluid viscosity we recommend to use our selection software available on [www.mpfiltri.com](http://www.mpfiltri.com).

Please, contact our Sales Department for further additional information.

## Hydraulic symbols

Filter series	Style 1 connection	Style 2 connections
<b>MPF 020</b>	•	
<b>MPF 030</b>	•	
<b>MPF 100</b>	•	
<b>MPF 104</b>	•	
<b>MPF 110</b>		•
<b>MPF 181</b>	•	
<b>MPF 182</b>		•
<b>MPF 184</b>	•	•
<b>MPF 191</b>	•	
<b>MPF 192</b>	•	
<b>MPF 194</b>	•	•
<b>MPF 400</b>	•	
<b>MPF 410</b>		•
<b>MPF 450</b>	•	
<b>MPF 451</b>		•
<b>MPF 750</b>	•	

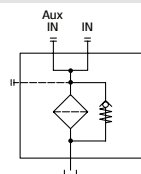
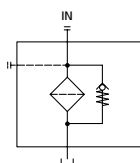

## Designation & Ordering code

### COMPLETE FILTER

<b>Series and size</b>	Configuration example 1:	MPF400	1	A	G9	A25	H	B	P01
<b>MPF400</b> Filter element with standard spigot	Configuration example 2:	MPF400	2	V	G4	P10	N	E	P01
<b>Length</b>									
1   2   3									
<b>Seals and treatments</b>									
A NBR									
V FPM									
W NBR head anodized									
Z FPM head anodized									
<b>Connections</b>									
G1 G 1 1/4"	G6 2" NPT								
G2 G 1 1/2"	G7 SAE 20 - 1 5/8" - 12 UN								
G3 G 2"	G8 SAE 24 - 1 7/8" - 12 UN								
G4 1 1/4" NPT	G9 SAE 32 - 2 1/2" - 12 UN								
G5 1 1/2" NPT									
<b>Filtration rating (filter media)</b>									
A03 Inorganic microfiber 3 µm	M25 Wire mesh 25 µm								
A06 Inorganic microfiber 6 µm	M60 Wire mesh 60 µm								
A10 Inorganic microfiber 10 µm	M90 Wire mesh 90 µm								
A16 Inorganic microfiber 16 µm	P10 Resin impregnated paper 10 µm								
A25 Inorganic microfiber 25 µm	P25 Resin impregnated paper 25 µm								
<b>Element Δp</b>	Filter media								
	Axx	Mxx	Pxx						
N 10 bar		•	•						
H 10 bar		•							
W 10 bar, compatible with fluids HFA, HFB and HFC	•	•							
	<b>Bypass valve</b>	<b>Execution</b>							
	E 3 bar	P01 MP Filtri standard							
	B 1.75 bar	Pxx Customized							

### FILTER ELEMENT

<b>Element series and size</b>	Configuration example 1:	MF400	1	A25	H	B		P01
<b>MF400</b> Filter element with standard spigot	Configuration example 2:	MF400	2	P10	N	V	E	P01
<b>Element length</b>								
1   2   3								
<b>Filtration rating (filter media)</b>								
A03 Inorganic microfiber 3 µm	M25 Wire mesh 25 µm							
A06 Inorganic microfiber 6 µm	M60 Wire mesh 60 µm							
A10 Inorganic microfiber 10 µm	M90 Wire mesh 90 µm							
A16 Inorganic microfiber 16 µm	P10 Resin impregnated paper 10 µm							
A25 Inorganic microfiber 25 µm	P25 Resin impregnated paper 25 µm							
<b>Element Δp</b>	Filter media							
	Axx	Mxx	Pxx					
N 10 bar		•	•					
H 10 bar		•						
W 10 bar, compatible with fluids HFA, HFB and HFC	•	•						
	<b>Seals</b>	<b>Bypass valve</b>	<b>Execution</b>					
	B NBR	E 3 bar	P01 MP Filtri standard					
	V FPM	1.75 bar	Pxx Customized					

### ACCESSORIES

<b>Indicators</b>	page		page
BVA Axial pressure gauge	240	BEA Electrical pressure indicator	239
BVR Radial pressure gauge	240	BEM Electrical pressure indicator	239
BVP Visual pressure indicator with automatic reset	241	BLA Electrical / visual pressure indicator	239-240
BVQ Visual pressure indicator with manual reset	241		
<b>Additional features</b>	page		
Sxx Extension tube	248		
T5 Filler plug M30x1.5	249		

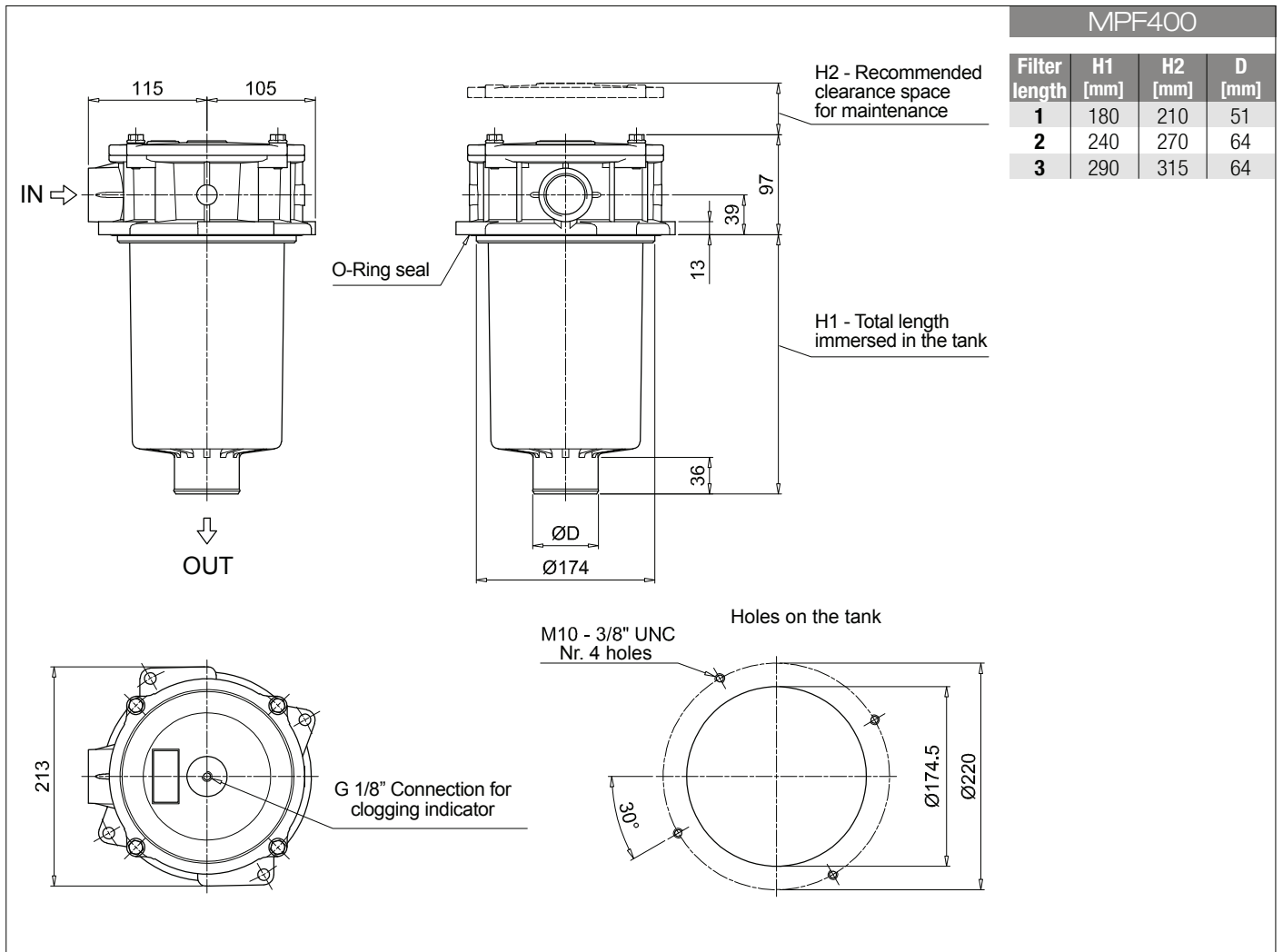

**MPF 100**

**MPF 181**

**O-RING SEAL**

	Q.ty: 1 pc. <b>2</b>	Q.ty: 1 pc. <b>3</b> (3a ÷ 3d)	
Item:		Seal Kit code number NBR	FPM
<b>MPF 030</b>		02050055	02050056
<b>MPF 100-110</b>		02050057	02050058
<b>MPF 181-182</b>		02050059	02050060
<b>MPF 184</b>	See order table	02050455	02050456
<b>MPF 191-192</b>		02050457	02050458
<b>MPF 194</b>		02050459	02050460
<b>MPF 400-410</b>		02050061	02050062
<b>MPF 450-451</b>		02050461	02050462
<b>MPF 750</b>		02050106	02050107

**MPF 104**

**MPF 181**

**FLAT SEAL**

	Q.ty: 1 pc. <b>2</b>	Q.ty: 1 pc. <b>3</b> (3a ÷ 3d)	
Item:		Seal Kit code number NBR	FPM
<b>MPF 020</b>		02050438	02050439
<b>MPF 104</b>	See order table	02050350	02050408
<b>MPF 181-182</b>		02050659	02050660
<b>MPF 191-192</b>		02050661	02050662